







**MEM Bath spout without diverter for free-standing assembly - Champagne (22kt Gold)**

MEM

13 672 780



- 280mm projection
- cascade
- total height 830 - 900 mm
- height up to aerator 665 – 735 mm
- push-on rosette 130 x 130 mm
- max. flow 47.8 l/min at 3 bar flow pressure

	Champagne (22kt Gold)	13 672 780-47
	Chrome	13 672 780-00
	Brushed Platinum	13 672 780-06
	Platinum	13 672 780-08
	Dark Chrome	13 672 780-19
	Brushed Durabronze (23kt Gold)	13 672 780-28
	Brushed Champagne (22kt Gold)	13 672 780-46

**Required miscellaneous**



- Concealed floor mounting -** 35 945 970 90
- max. recess depth 150 mm
  - min. recess depth 80 mm

**MEM Bath spout without diverter for free-standing assembly - Champagne  
(22kt Gold)**

MEM

13 672 780  
mm [inches]

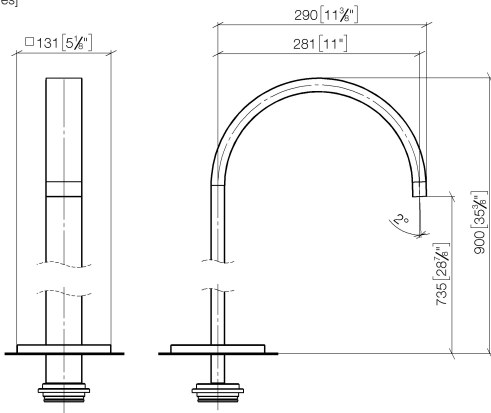

Flow rate chart



13 672 780

